

USER MANUAL

— A21 DRONE —

Please read this manual before operating your drone,
and keep it for further reference.

AKASO®

CONTENTS

| | |
|-------------------------------------|----|
| Warning | 1 |
| Parts of choose and buy | 2 |
| The drone | 3 |
| Transmitter | 3 |
| Battery installation | 4 |
| Charging the battery | 4 |
| Ready to fly | 5 |
| Insert battery & Open the power | 5 |
| Calibration drone | 5 |
| One key take off / Landing & E-stop | 6 |
| Optical flow positioning | 7 |
| Headless mode function | 7 |
| One key return | 8 |
| Flight control | 8 |
| Problem solving guidelines | 9 |
| Control by app | 12 |
| Contact US | 16 |

WARNING!

- * Please follow the instruction or packing instructions for proper installation and use. Some parts are assembled by adults.
- * The product contains small parts that may create a risk of ingestion or suffocation.
- * Please promptly put away the packing materials to avoid harm to children.
- * It is necessary to regularly check the charger, wires, plugs, housings and other components.
If any damage is found, it should be stopped until it is properly repaired.
- * Chargers, battery case and other charging devices need to be inserted into the same specified power supply as the product's designation.
- * Can only use the original configuration charger, the charger is not a toy.
- * Disconnect the charger before cleaning the toy.
- * Non-rechargeable battery is not rechargeable.
- * When charging the battery, adult supervision is required.
- * Do not mix old and new batteries or different types of batteries. Exhausted batteries should be removed in time.
- * Do not short-circuit the battery, disassemble it, drop it at a high altitude or throw it into the fire.
- * Do not operate the product for a long time, please remove the battery.
- * Do not touch the rotating parts with your hands to avoid personal injury.
- * Do not hit or drop the drone and remote control severely.
- * Please clean the product with a clean, soft cloth.
- * It is the user's responsibility to ensure that the product does not cause harm to himself or others. The manufacturer and distributor shall not be liable for any damage or property damage caused by improper operation.
- * This package and manual contains important product information, please keep it.

PARTS OF CHOOSE AND BUY

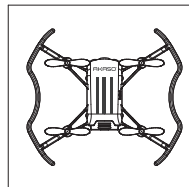

A21 drone

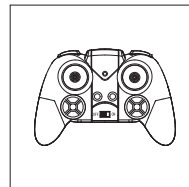

Remote Control

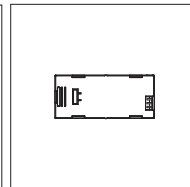

Lithium Battery

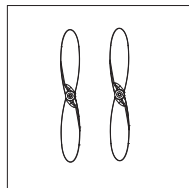

Spare Propellers A

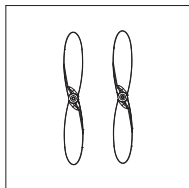

Spare Propellers B

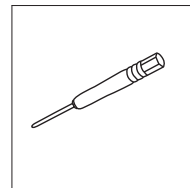

Screw Driver

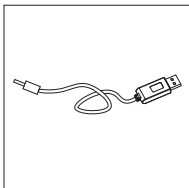

USB Charging Line



Quick Reference Guide

THE DRONE

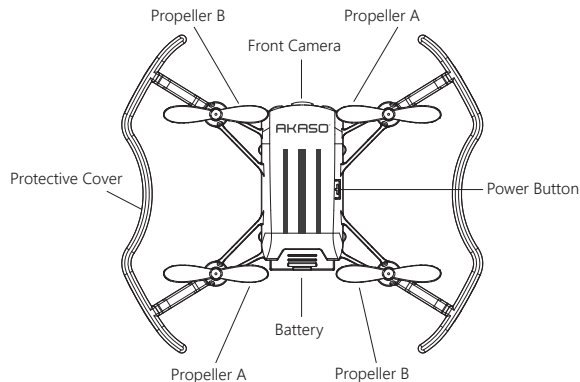

TRANSMITTER

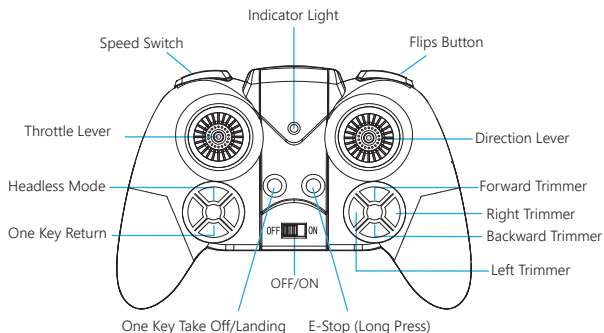

BATTERY INSTALLATION

Open up the battery cover at the back of the remote control. Correctly place 3xAAA batteries in the battery box in strict adherence to the polarity instructions, install the battery cover and tighten the screw (AAA battery not included).

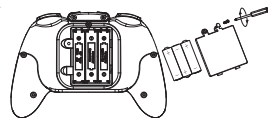

Note:

- During the battery installation, it must be ensured that the polarities of the batteries are matched with the battery box. No battery shall be installed with the opposite polarity.
- Please do not use new and old batteries or different types of batteries together.
Lithium battery of drone charging instruction (Please take out the lithium battery from the drone before charging).

CHARGING THE BATTERY

The usb charging cable can be used with 5V 2A adapter or computer USB port.

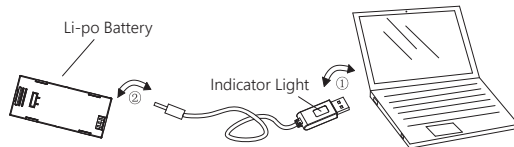

Note: The red indicator light stays off during charging, and turns on when fully charged.

1. Insert Battery & Open The Power

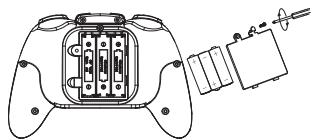

① 3x1.5V AAA battery-not included.

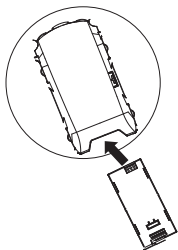

② Insert battery into battery compartments.

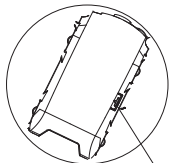

③ Long press the power switch.

Power Switch (Long Press)

2. Calibration Drone

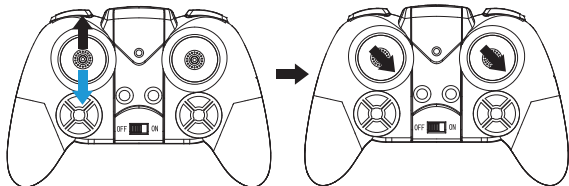

- ① Turn on the transmitter. (The LED indicator will flash.)
- ② Connect the power of the drone; the drone lights will flash.
- ③ Quickly push the left stick up and down, then push the stick down to the right 45 degree at the same time. The transmitter sound will beep, and the LED indicator will turn solid. When the lights of the drone stop flashing and turn solid, it indicates that the drone is ready to fly.

3. One Key Take Off / Landing & E-stop

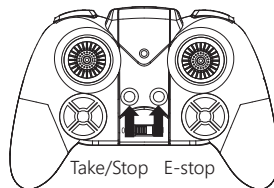

① Take off / Landing

1. Press the "Take off / Stop" button to start the drone. The propellers will spin, gently push the throttle lever upwards to take off the drone.
2. Press the "Take off / Stop" button during the flight, the drone will slow down to the ground and stop flying.

② Emergency Stop

In the event of an accidental drop or a dangerous situation during a flight, press and hold the emergency stop for a long time and the drone will quickly stop working.

4. Optical Flow Positioning

- ① Optical flow hover system automatically turns on once the drone takes off.
- ② The optimum height of optical flow hover is 3 meters, maximum can up to 8 meters.
- ③ On the clear-grained ground, the horizontal offset is accurate to about 10 cm.

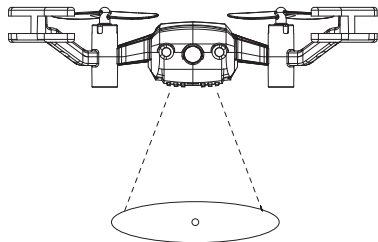

5. Headless Mode Function

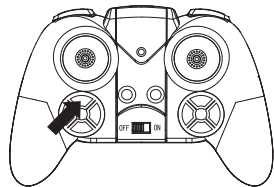

① About headless mode

Headless mode makes it easier to control the steering of the drone. When headless mode is off, the direction that the head of the drone faces would be the forward direction. In headless mode, the direction the pilot faces would be the forward direction.

② Use headless mode function

Press down the headless mode button to enter into headless mode. The transmitter will keep beeping slowly in headless mode, the lights of the drone will also keep flashing. Press down the button again to exit the headless mode.

6. One Key Return

- ① Press the one key return button, the remote control will issue a "Di" sound, enter the return mode, the drone will fly back in the direction of calibrating.
- ② When the drone is too close to yourself, do not operate the one key return, to avoid injury caused by careless. During the one key return mode, push the direction lever to the direction forward or backward that can exit.

7. Flight Control

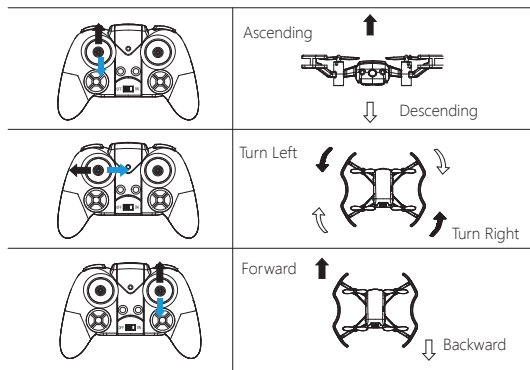

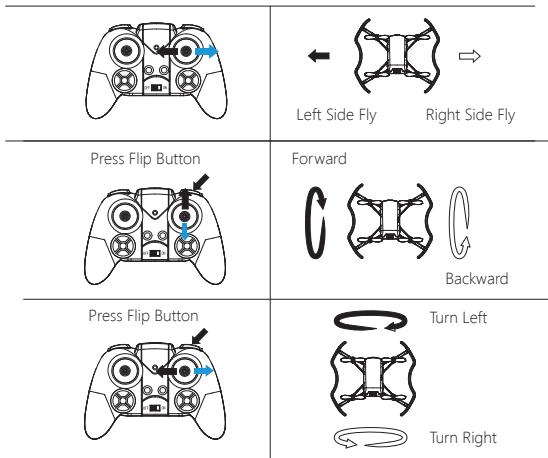

Note: Please fly the drone to a height 3 meters or more, and then perform the roll control mode. If the drone can not vertically take off, it can be calibrated.

PROBLEM SOLVING GUIDELINES

Push slowly of the throttle lever. When the drone rise at about 1.5 meters, if the drone spinning in the air or tends in different directions, you can use trimmer to correct the drone.

Note: When the drone is located 30 centimeters from the ground, the drone will become unstable due to the influence of its own swirling eddy currents. This is called the "Gravity Reaction" When the weight of the drone is lighter, the effect of the ground "Gravity Reaction" is greater.

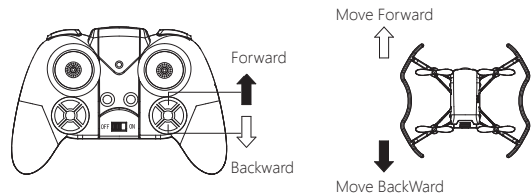

When offset forward, fine tune backward adjustment until it is repaired. When offset backwards, fine tune forward adjustment until repaired.

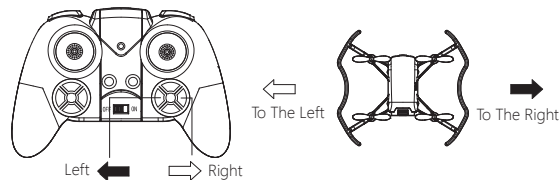

When offset to the left, fine tune to the right until it is repaired. When offset to the right, fine tune to the left until it is repaired.

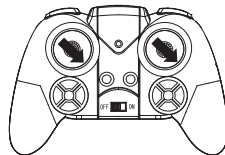

If the drone can not vertically take off, it can be calibrated. Press the throttle lever and the direction lever to the lower right corner at the same time, at this moment, the indicator light of the drone will flashing rapidly and then release all the actions of the remote controller. When the indicator light keep on steady, means the calibration is successful.

| Question | Reason | Solution |
|--------------------------------|--|---|
| Drone can't be controlled | The drone did not calibrating or failed. | According to the calibration drone steps to re-pair your drone. |
| The drone shakes badly | 1. Blades deformation. 2. Hollow shaft bending. | 1. Replace the new blade. 2. Replace the new hollow shaft. |
| Take off always flies one side | 1. Propellers deformation. 2. One motor damage. 3. The drone is not in a horizontal position when re-pair drone. | 1. Replace new propellers. (A or B) 2. Replace the new motor. (A or B) 3. Place the drone on a horizontal ground and re-pair the code. |
| Out of control | 1. Exceeding effective control distance. 2. There are multiple drones that turn on the power at the same time. | 1. Make sure to control within a radius of 50 meters. 2. Please repair the drone (When multiple drones are coded, you need to repair them one by one to avoid wrong or not fit). |
| The drone can't fly high | 1. The blades rotating is too slow. 2. Drone battery is low. | 1. Push the joystick lever up slowly. 2. Replace the full battery or fully charge the battery. |
| The drone landed too fast | Too Quickly pull back the joystick. | When the drone descends, slowly pull back the joystick. |
| One propeller doesn't work | 1. One motor damage. 2. Installed propellers with wrong number. | 1. Replace the new motor(A or B). 2. Please install the correct propellers. |

Note:

1. The remote control distance will be affected when the power of the remote control or drone battery is low.
2. If the drone is not enough power, there will be insufficient altitude or difficult take-off.
3. If the drone is damaged or deformed please promptly repaired. In severe cases such as broken propellers or damaged, do not fly, otherwise it may cause injury.
4. Please remove the battery of the remote controller when it is not used for a long time to avoid damage to the product caused by battery leakage.

5. Do not allow the drone to crash or collide seriously from high altitude, which may damage the drone or shorten the service life of the drone.
6. In order to ensure the stability of the drone, when the drone suddenly hit the object after falling, please put the drone on the ground for 2-3s, until the drone automatically detects the level, and then control.

CONTROL BY APP

iOS: Please download the FLORLD app from APP Store.

Android: Please download the FLORLD app from Google Play Store.

For Apple user please scan:



For Android user please scan:







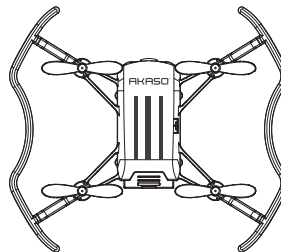











Connect WiFi signal:

Choose the WiFi signal of the drone(FLD-*****).





- | | | |
|--|---|--|
|  Photo |  Video |  G-sensor |
|  Speed |  360 Flip |  Flight route setting |
|  Hidden Interface |  Altitude Hover Mode |  Setting |
|  Balance Mode |  Rotation Mode |  VR Mode |
|  Headless Mode |  Stop |  One Key Flight |
|  One Key Landing |  None | |

About the app



FREE FLIGHT: Open the operation interface.



FOLDER: Photos and videos will be saved here.

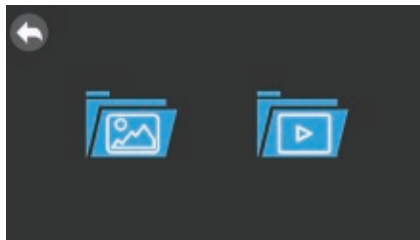

CHOREOGRAPHY: Open the choreographer flight interface



HELP:

1. Open the power supply for the drone and put it on the horizontal plane.
2. Open APP and click "connect WiFi".
3. Select the connection in the WiFi option.
4. Return to the main interface and click "free flight".



SET UP:

Right hand mode

Language switching (only Chinese and English)

Automatic preservation

Sound



CONTACT US

For any inquires, issue or comments concerning our products, please send E-mail to the address below, and we will respond as soon as possible.

E-mail: cs@akasotech.com